

MATERIALITY & ASSEMBLY

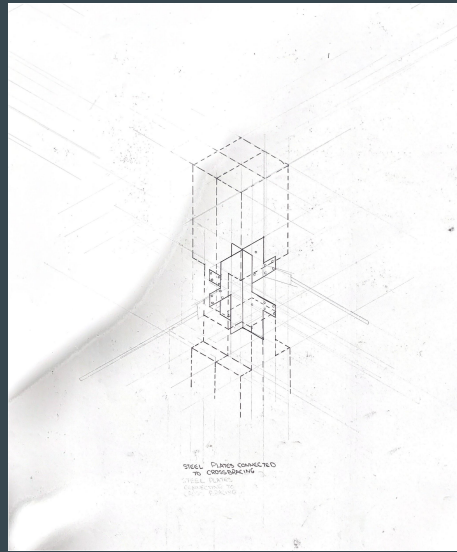

KATE CHOOCHIEW

Assembly 1

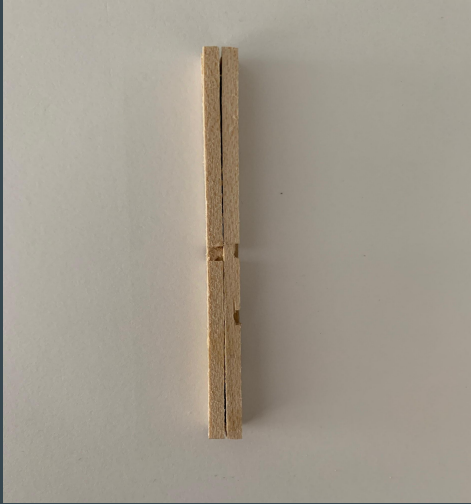

Assembly 2

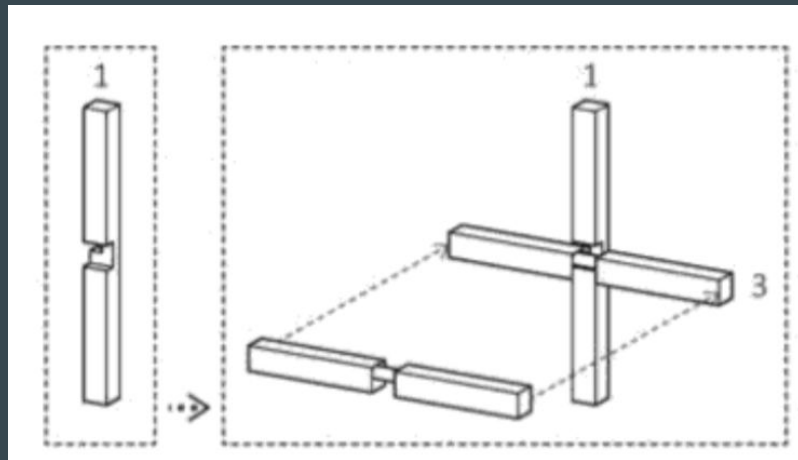
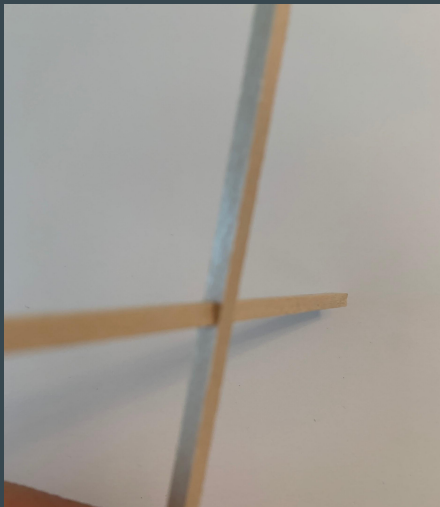
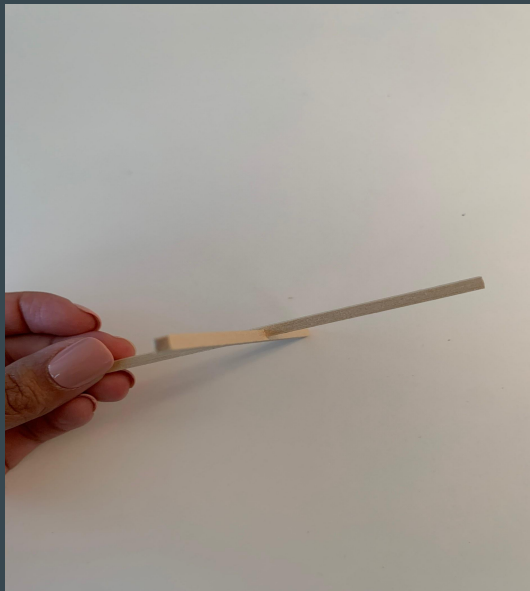

Assembly 3

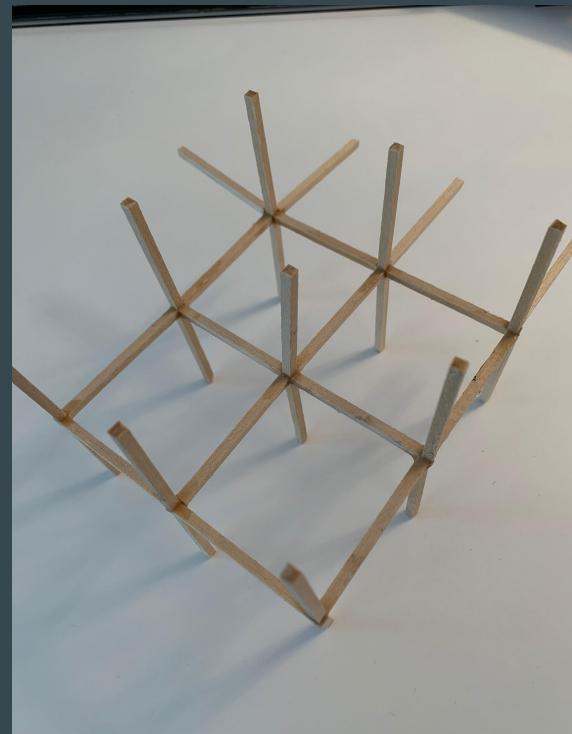
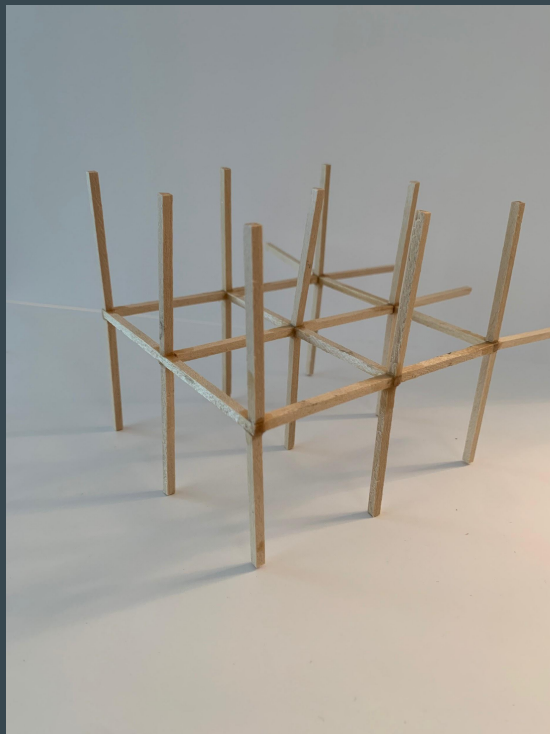

Assembly 4

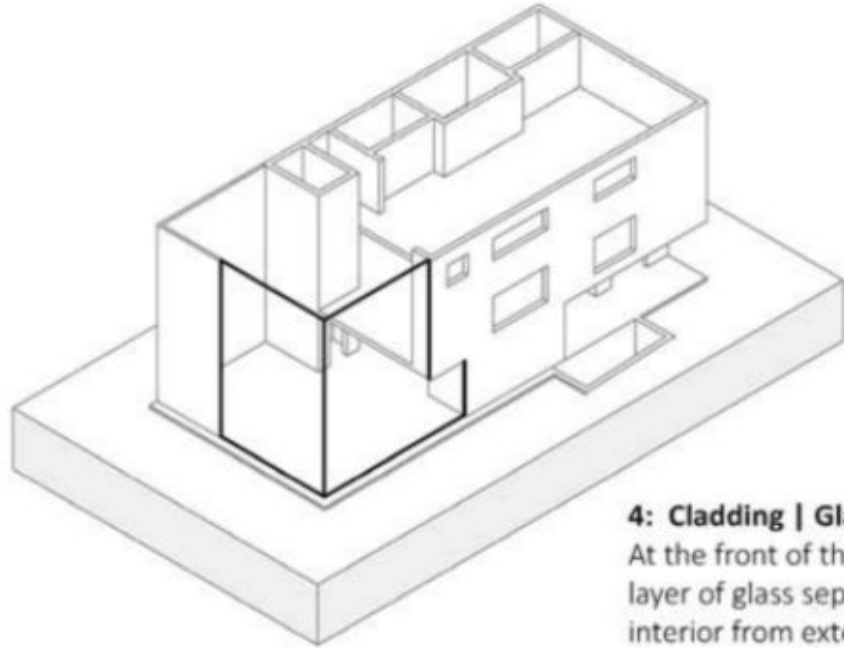
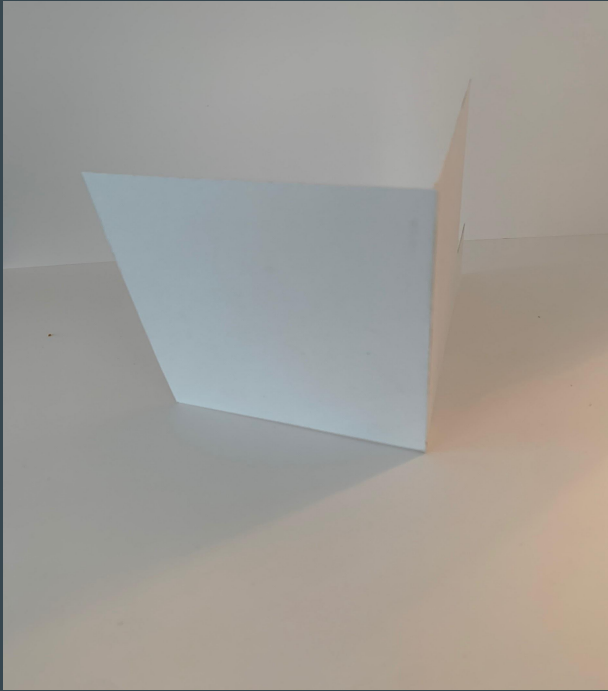

4: Cladding | Glass

At the front of the building, a layer of glass separates interior from exterior. This glass is set within the wooden framework.

Assembly 5

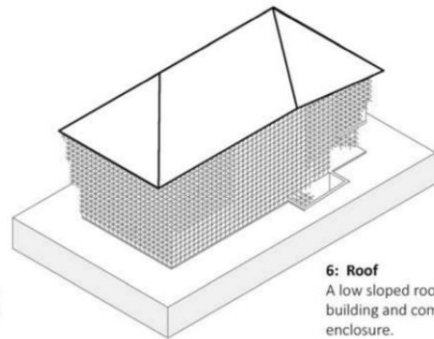
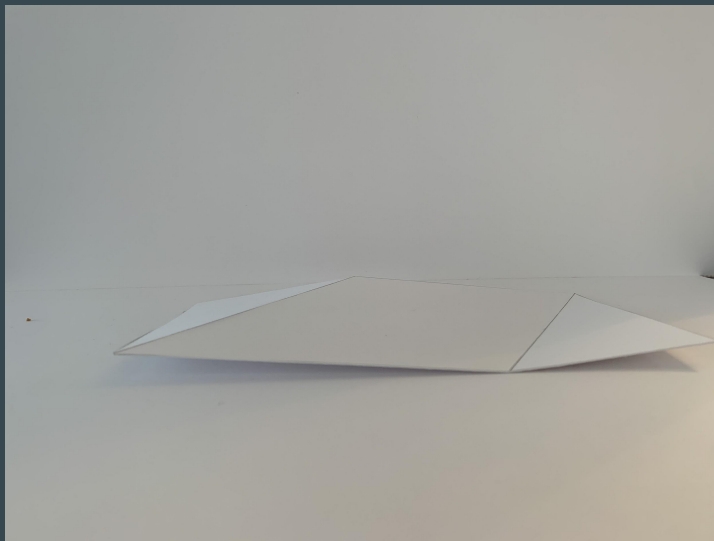

6: Roof
A low sloped roof caps the building and completes the enclosure.