



# Studio 1

Final Project - MOMA Interior Pavilion



# First Iteration - Physical Model at $\frac{1}{2}''=1'$ Scale



# First Iteration Drawings

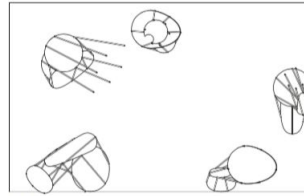

PLAN A  
SCALE 1/8"=1'-0"

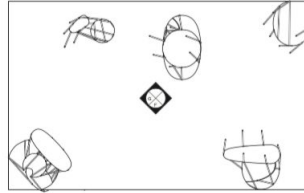

PLAN B  
SCALE 1/8"=1'-0"

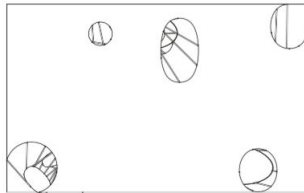

PLAN C  
SCALE 1/8"=1'-0"

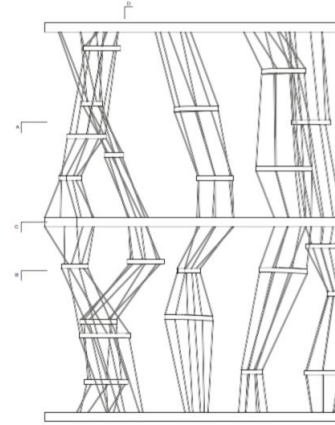

ELEVATION A  
SCALE 1/8"=1'-0"

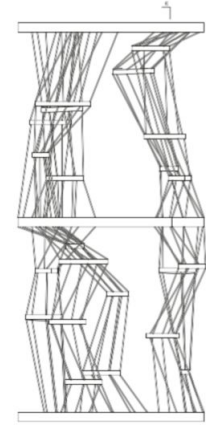

ELEVATION B  
SCALE 1/8"=1'-0"

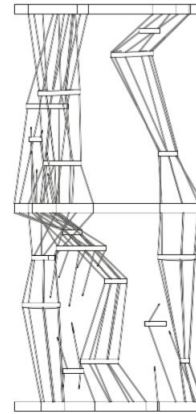

SECTION D  
SCALE 1/8"=1'-0"

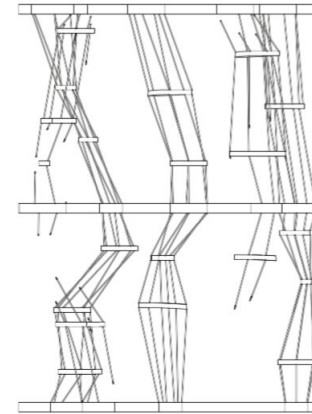

SECTION E  
SCALE 1/8"=1'-0"

# Second Iteration - Physical Model at $\frac{1}{2}''=1'$ Scale

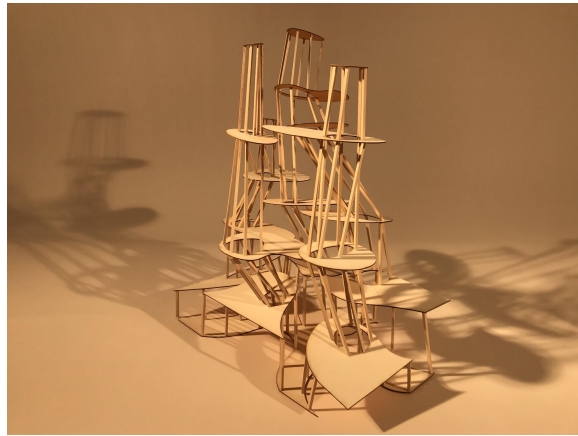
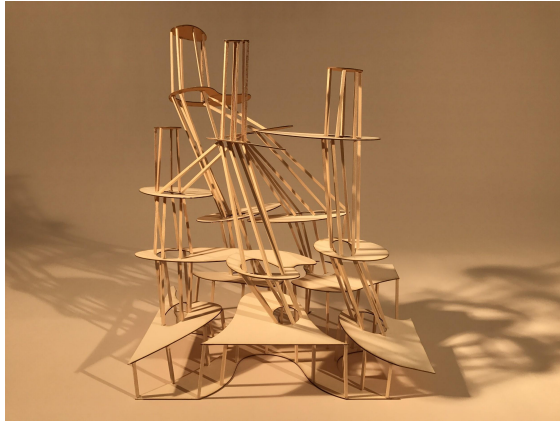

# Second Iteration Drawings

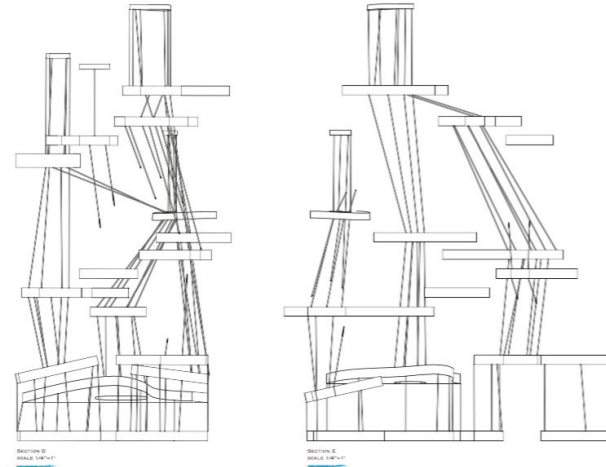
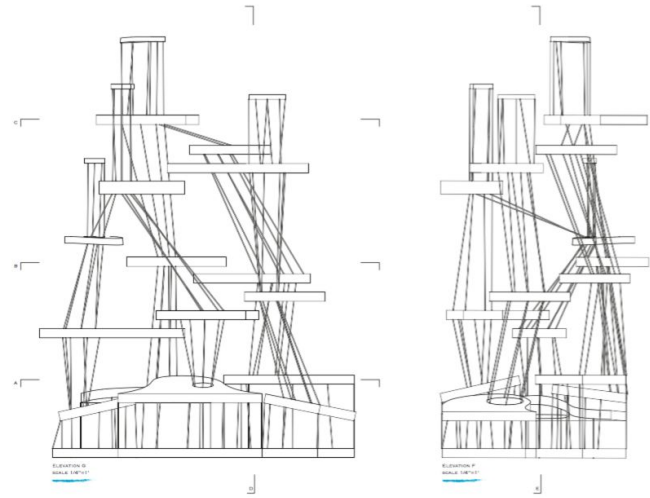
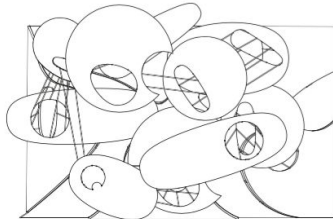
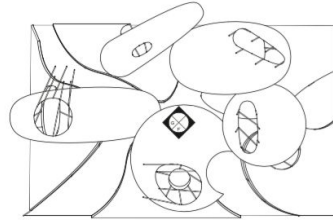
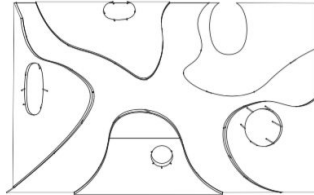

# Third Iteration Drawings

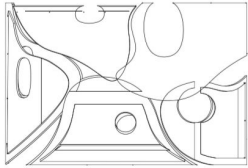

PLAN 1  
SCALE 1:100

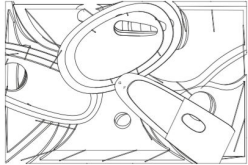

PLAN 2  
SCALE 1:100

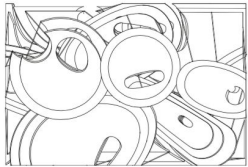

PLAN 3  
SCALE 1:100

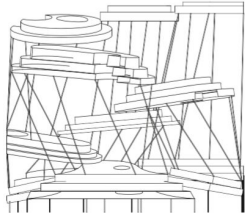

SECTION 1  
SCALE 1:100

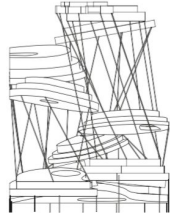

SECTION 2  
SCALE 1:100

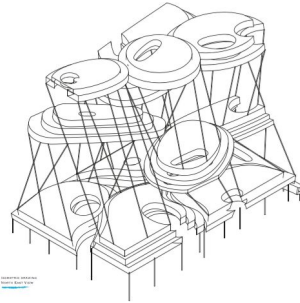

SECTION 3  
SCALE 1:100

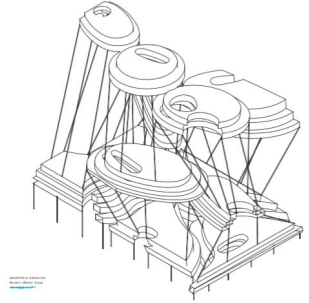

SECTION 4  
SCALE 1:100



SECTION 5  
SCALE 1:100

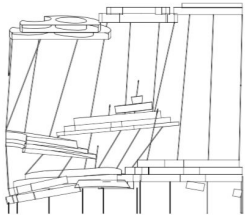

SECTION 6  
SCALE 1:100

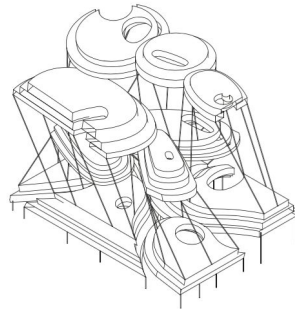

SECTION 7  
SCALE 1:100



SECTION 8  
SCALE 1:100

# Fourth/Final Iteration - Physical Model at $\frac{1}{2}''=1'$ Scale

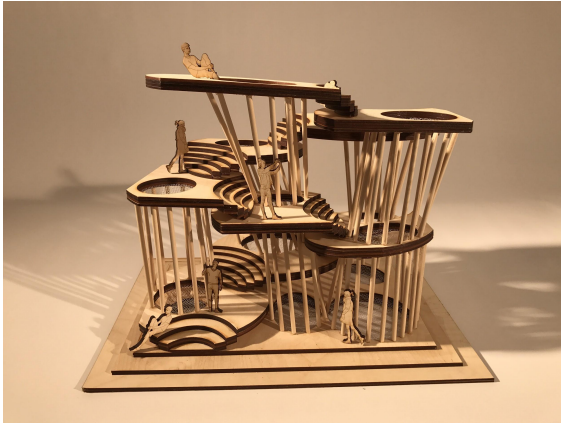

# Fourth/Final Iteration - Physical Model & Site Model at $\frac{1}{8}''=1'$ Scale

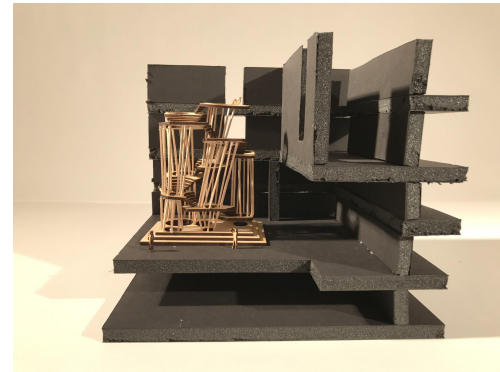
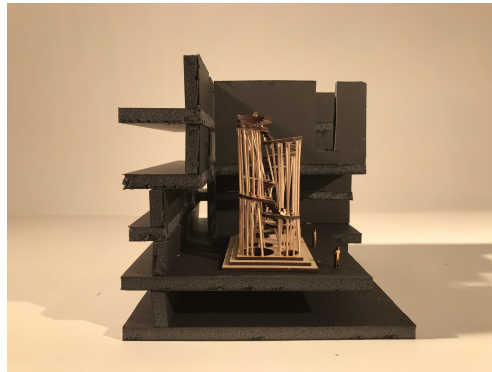
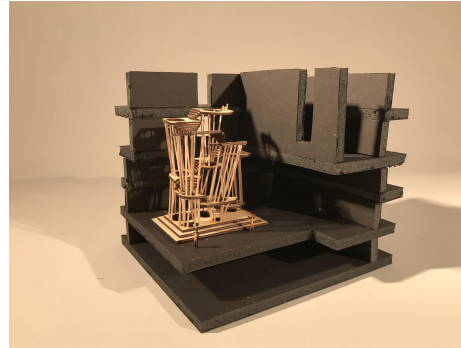
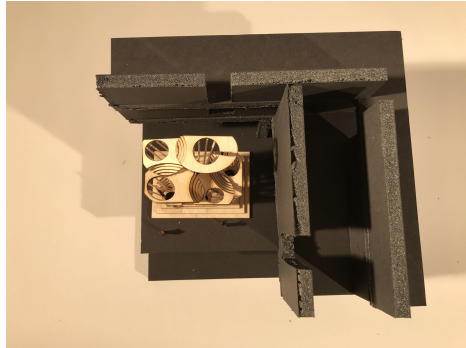



# Fourth/Final Iteration - Boards



PROGRAM BOARD

DEPICTING FUNCTIONS / ACTIVITIES OF THE PAVILION



INHABITING COLUMNS

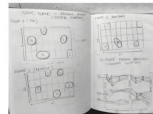

GRID - CREATION OF COLUMNS



FLOOR PLATES - SHAPE

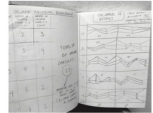

GRID - CREATION OF COLUMNS



POSITIONING OF PLATES

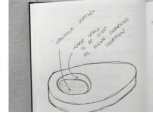

FLOOR PLATES - GENERAL DESIGN

DIAGRAMS & SKETCHES

CONCEPT, POSITIVE / NEGATIVE SPACE, PROGRAM  
CIRCULATION, FUNCTIONAL FEATURES, DETAILS, ETC.

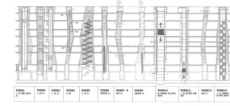
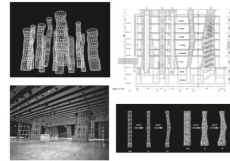
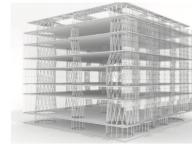

MAIN INSPIRATION

TOYO ITO'S SENDAI MEDIATHEQUE // JAPAN  
LIBRARY

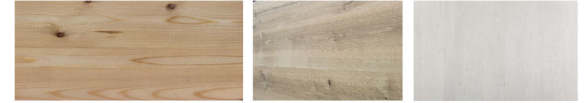

MATERIALS BOARD

# Fourth/Final Iteration - Plans

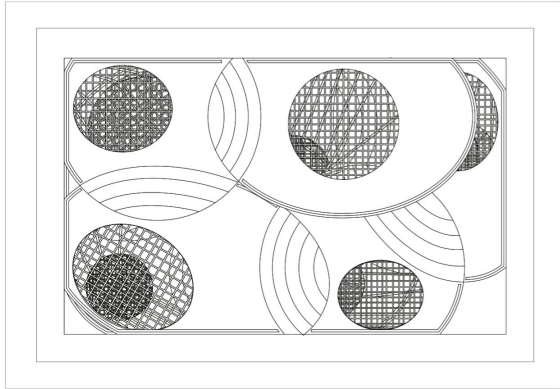

ROOF PLAN A  
SCALE 1/2"=1'

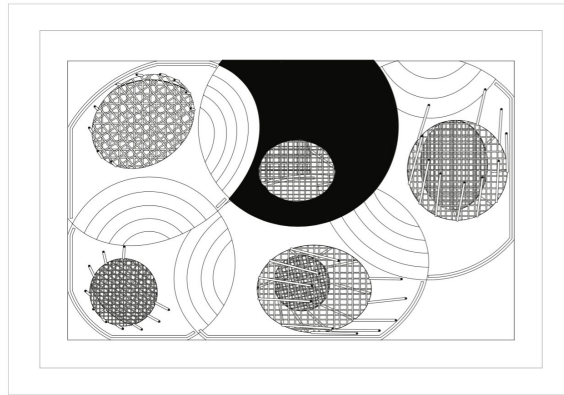

PLAN B  
SCALE 1/2"=1'

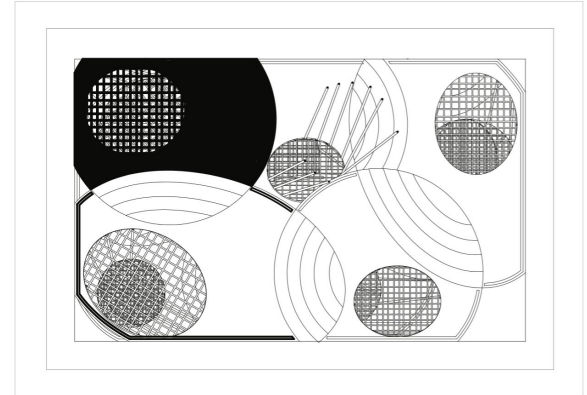

PLAN C  
SCALE 1/2"=1'

# Fourth/Final Iteration - Sections

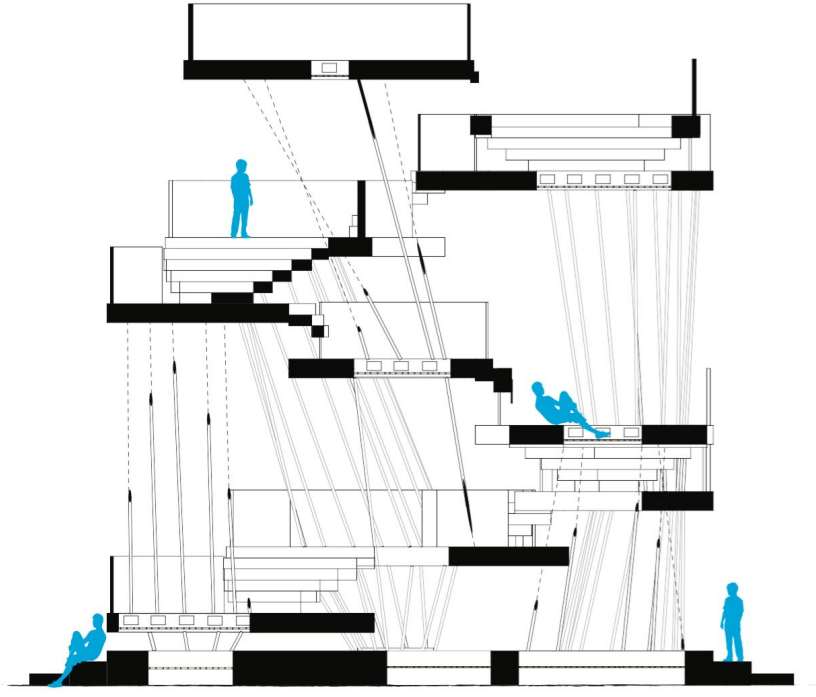
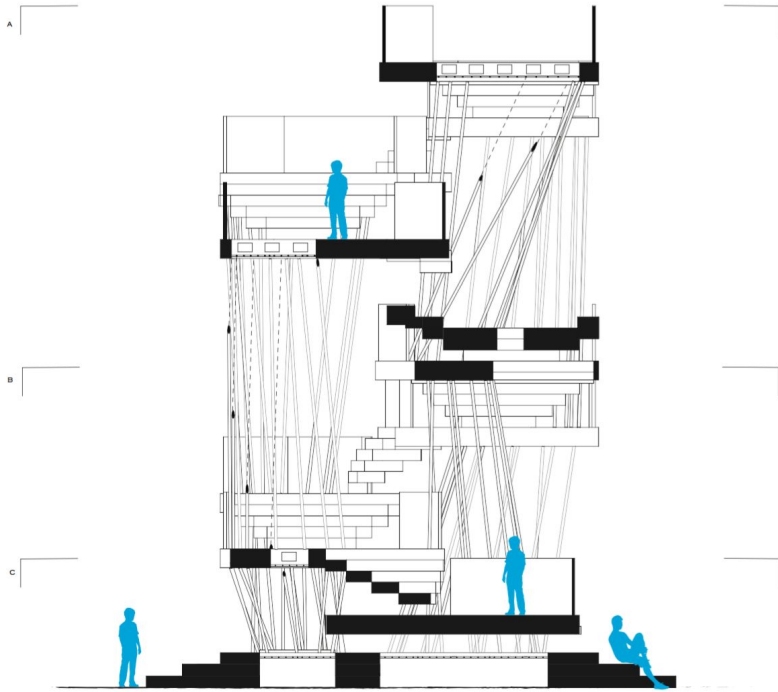

# Fourth/Final Iteration - Site Context Drawings

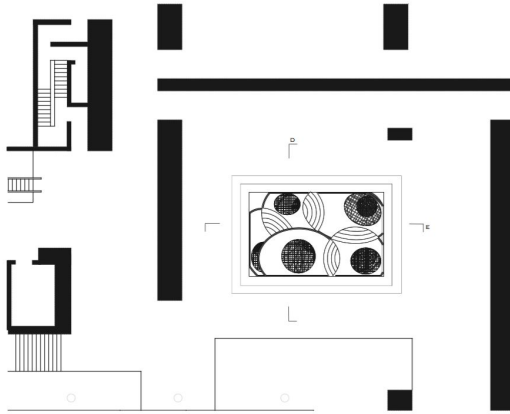

ROOF PLAN A INCLUDING SITE CONTEXT  
SCALE 1/8"=1'

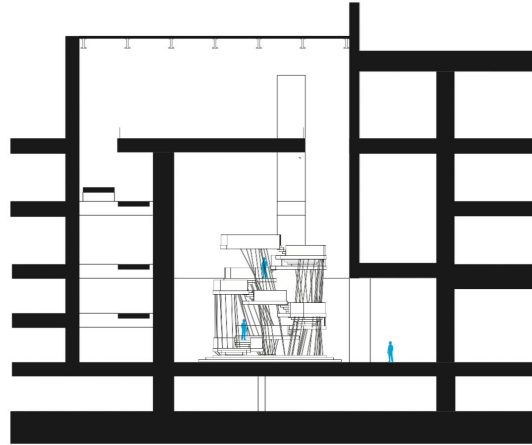

ELEVATION F INCLUDING SITE CONTEXT  
SCALE 1/8"=1'

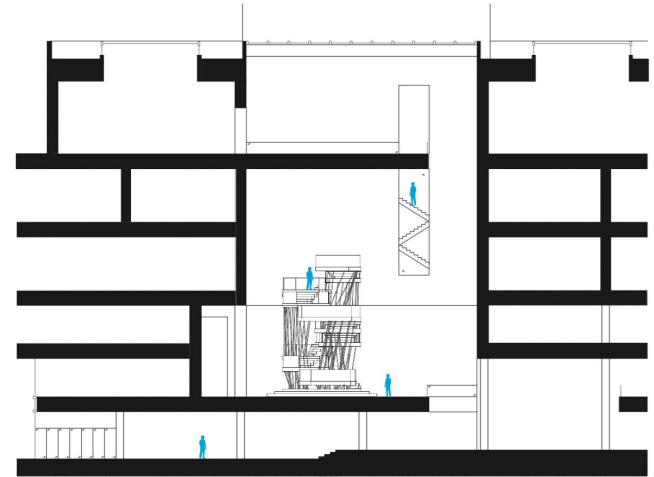

ELEVATION G INCLUDING SITE CONTEXT  
SCALE 1/8"=1'

# Fourth/Final Iteration - Perspectives

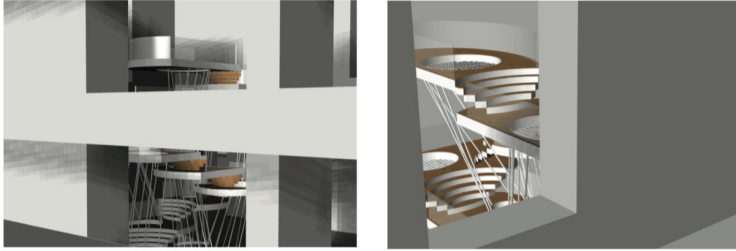

PERSPECTIVES

VIEW FROM UPPER LEVELS OF THE MOMA



PERSPECTIVES

GROUND VIEW

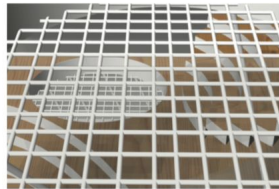
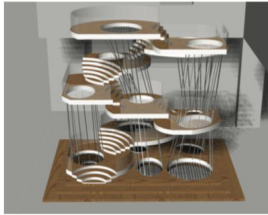
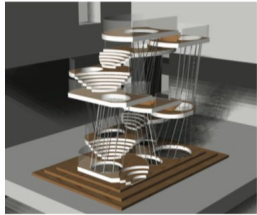
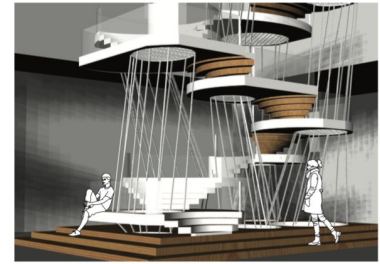

PERSPECTIVES

BIRDS EYE VIEW OF PAVILION & NET



PERSPECTIVES

VIEW FROM WITHIN PAVILION

